

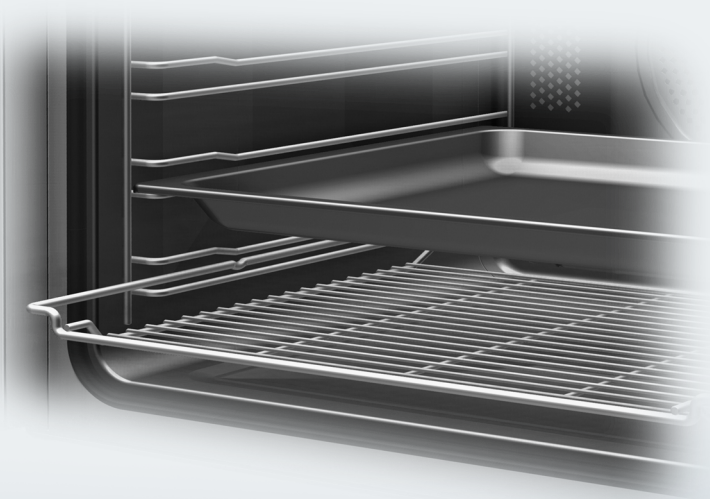

Operating and installation instructions



Oven



To prevent the risk of accidents or damage to the appliance, it is **essential** to read these instructions before it is installed and used for the first time.

Contents

Warning and Safety instructions	5
Caring for the environment	16
Oven overview	17
Oven controls	18
Function selector	19
Oven functions	19
Temperature selector	19
Clock/Timer	19
Display	19
Buttons	19
Features	20
Model numbers	20
Data plate	20
Items supplied with delivery	20
Standard and optional accessories	20
Shelf runners	21
Universal tray and rack with anti-tip safety notches	21
FlexiClip telescopic runners	22
Fitting and removing the FlexiClip telescopic runners	22
Oven controls	25
Safety features	25
System lock  for the oven	25
Cooling fans	25
Vented oven door	25
PerfectClean treated surfaces	26
Rear catalytic enamelled liner	26
Using for the first time	27
Before using for the first time	27
Setting the time of day for the first time	27
Heating up the oven for the first time	28
Overview of functions	29
Tips on saving energy	30
Operation	32
Using the oven	32
Cooling fans	32
Pre-heating	33

Clock/Timer	34
Display	34
Symbols in the display	34
Buttons	34
How to set the time or a duration	35
Displaying times/durations	35
When the time/duration has elapsed	35
Using the minute minder 	36
Setting the minute minder	36
To change the time set for the minute minder	37
To cancel the time set for the minute minder	37
Switching cooking programmes on and off automatically	38
Setting a cooking duration	38
At the end of the cooking duration	39
Setting a cooking duration and finish time	40
Changing the cooking duration	41
Deleting a cooking duration	42
Deleting a finish time	42
Changing the time of day	43
Changing settings	44
Baking	46
Notes on the baking chart	47
Baking chart	48
Roasting	52
Notes on the roasting chart	52
Roasting chart	54
Low temperature cooking	56
Grilling	58
Notes on the grilling chart	59
Fan Grilling guide (Fan Grill )	61
Grilling guide (Full Grill )	62
Defrost	63
Bottling	64
Drying food	65
Frozen food / Ready-meals	66
Gentle Bake	67

Contents

Cleaning and care	68
Useful tips	69
Normal soiling	69
Cleaning the seal	69
Stubborn soiling (does not apply to the FlexiClip telescopic runners)	70
Stubborn soiling on the FlexiClip telescopic runners	71
Cleaning the catalytic enamelled back panel	71
Removing soiling caused by spices, sugar and similar deposits	71
Removing oil and grease soiling from the catalytic enamelled panel	72
Removing the door	73
Dismantling the door	74
Fitting the door	77
Removing the shelf runners with FlexiClip telescopic runners	78
Removing the back panel	79
Lowering the top heat/grill element	79
Problem solving guide	80
After sales service and warranty	84
Electrical connection	85
Building-in diagrams	87
Appliance dimensions and unit cut-out	87
Front dimensions	89
Installing the oven	90
Contact details	91

Warning and Safety instructions

This appliance conforms to current safety requirements. Inappropriate use can, however, lead to personal injury and damage to property.

To avoid the risk of accidents and damage to the appliance, please read these instructions carefully before using it for the first time.

They contain important notes on installation, safety, use and maintenance.

Miele cannot be held liable for non-compliance with these instructions.

Keep these instructions in a safe place and ensure that new users are familiar with the contents. Pass them on to any future owner.

Warning and Safety instructions

Correct application

▶ This oven is designed for domestic use and for use in similar environments by guests in hotel or motel rooms, bed & breakfasts and other typical living quarters. This does not include common/shared facilities or commercial facilities within hotels, motels or bed & breakfasts.

▶ The oven is not suitable for outdoor use.

▶ The oven is intended only to cook, bake, roast, grill, defrost, bottle, dry fruit etc.

Any other usage is at the owner's risk.

▶ This oven is not intended for use by persons (including children) with reduced physical, sensory or mental capabilities, or lack of experience and knowledge, unless they are supervised whilst using it or have been given instruction concerning its use by a person responsible for their safety.

They must be able to recognise the dangers of misuse.

Safety with children

- ▶ Young children must not be allowed to use this appliance.
- ▶ Older children may only use the appliance when its operation has been clearly explained to them and they are able to use it safely, recognising the dangers of misuse.
- ▶ Cleaning work may only be carried out by older children under the supervision of an adult.
- ▶ Children should be supervised near the appliance. Ensure that they do not play with the appliance.
- ▶ Children may be able to wrap themselves in packing material or pull it over their heads with the risk of suffocation. Keep children away from any packing material.

Warning and Safety instructions

▶ Danger of burning!

Children's skin is far more sensitive to high temperatures than that of adults. Great care should be taken to ensure that children do not touch the appliance when it is being used. External parts of the oven such as the door glass, control panel and the vents become quite hot.

▶ Danger of injury!

The maximum load capacity for the door is 15 kg. Children can hurt themselves on an open door.

Ensure that children do not sit on or swing on the door.

Technical safety

- ▶ Repairs and other work by unqualified persons could be dangerous. Installation, maintenance work and repairs to electrical appliances must only be carried out by a Miele approved service technician.
- ▶ A damaged appliance is dangerous. Check it for any visible damage. Never install or attempt to use a damaged appliance.
- ▶ Reliable and safe operation of this oven can only be assured if it has been connected to the mains electricity supply.
- ▶ The electrical safety of this appliance can only be guaranteed when continuity is complete between it and an effective earthing system. It is most important that this basic safety requirement is present and tested regularly and, where there is any doubt, the household wiring system should be inspected by a qualified electrician.
- ▶ Before connecting the appliance to the mains supply, make sure that the rating on the data plate (voltage and frequency) corresponds to that of the household supply. This data must correspond in order to avoid risk of damage to the appliance. Consult a qualified electrician if in any doubt.
- ▶ Do not connect the appliance to the mains electricity supply by a multi-socket unit or an extension lead. These do not guarantee the required safety of the appliance (e.g. danger of overheating).
- ▶ For safety reasons, this appliance may only be used when it has been built in.
- ▶ This oven must not be installed and operated in mobile installations (e.g. on a ship).

Warning and Safety instructions

▶ Tampering with electrical connections or components and mechanical parts is highly dangerous to the user and can cause operational faults.

Do not open the outer casing of the appliance.

▶ The manufacturer's warranty will be invalidated if the appliance is not repaired by a Miele approved service technician.

▶ Faulty components must only be replaced by genuine Miele spare parts. The manufacturer can only guarantee the safety of the appliance when Miele replacement parts are used.

▶ If the oven is delivered without a connection cable, or if the connection cable supplied is damaged, a special connection cable must be installed by a Miele approved service technician (see "Electrical connection").

▶ During installation, maintenance and repair work, the appliance must be disconnected from the mains electricity supply, e.g. if the oven lighting is faulty (see "Problem solving guide").

It is only completely isolated from the electricity supply when:

- it is switched off at the mains circuit breaker, or
- it is switched off at the wall socket and the plug is withdrawn from the socket.

Do not pull the mains connection cable but the mains plug to disconnect your appliance from the mains electricity supply.

Warning and Safety instructions

► For the oven to function correctly, it requires a sufficient intake of cool air. Ensure the intake of cool air to the oven is not impaired (e.g. due to the installation of insulation material inside the housing unit). Furthermore, the incoming cool air must not be excessively heated by other heat sources (e.g. fuel furnaces).

► If the oven is installed behind a furniture door, do not close the door while the oven is in operation. Heat and moisture would build up behind a closed furniture door, potentially causing damage to the oven, the furniture unit and the flooring. Wait until the oven has cooled down completely before closing the furniture door.

Warning and Safety instructions

Correct use

 Danger of burning!

The oven becomes hot when in use.

Exercise care when handling food and trays so as not to burn yourself on heating elements, the walls of the oven, shelf runners, trays and hot food itself.

Use oven gloves when placing food in the oven, turning or removing it and when adjusting oven shelves etc. in a hot oven.

▶ Do not use the oven to heat up the room.

Due to the high temperatures radiated, objects left near the appliance could catch fire.

▶ Never leave the appliance unattended when cooking with oil or fats as these are a fire hazard if allowed to overheat.



Do not attempt to extinguish oil or fat fires with water.

Switch off the oven and smother the flames by keeping the oven door closed.

▶ Make sure that you keep to the recommended grilling times when using grilling functions.

Excessively long grilling times can lead to food drying out and burning or could even cause the food to catch fire.

Warning and Safety instructions

- ▶ Some foods dry out very quickly and can be ignited by high grilling temperatures. Do not use grilling functions for crisping rolls or bread or to dry flowers or herbs. Instead use Fan Plus  or Conventional Heat .
- ▶ If using alcohol in your recipes, please be aware that high temperatures can cause the alcohol to vaporise and even to ignite on the hot heating elements.
- ▶ When residual heat is used to keep food warm, the high level of humidity and condensation can cause corrosion in the oven. The control panel, worktop or furniture unit may also be damaged. Do not switch the oven off completely while food is inside it, but select the lowest possible temperature for the oven function you are using. This will ensure the fan will automatically continue to run.
- ▶ Cover any food which is left in the oven to be kept hot, as moisture in the food could lead to corrosion damage in the oven. This also prevents the food from drying out.
- ▶ Never cover the floor of the oven with aluminium foil, or place oven dishes, pans, saucepans or trays directly onto the floor of the oven. This would cause concentrations of heat which could cause damage to the floor of the oven.
- ▶ When storing pots or pans in the oven, do not slide them across the floor of the oven as this will damage the enamel coating.

Warning and Safety instructions

- ▶ Never pour cold water onto hot surfaces in a hot oven. The steam created could cause serious burns or scalding and the sudden change in temperature can damage the enamel in the oven.
- ▶ It is important that the heat is allowed to spread evenly throughout the food being cooked. This can be achieved by stirring and/or turning the food.
- ▶ Plastic containers, which are not heat-resistant, melt and may ignite at high temperatures and can damage the oven. Use only plastic containers that are indicated by the manufacturer as being suitable for use in ovens.
- ▶ Do not use the appliance to heat up or bottle food in sealed jars and tins. Pressure will build up inside them and they can explode causing damage to the appliance, as well as the risk of injury and scalding.
- ▶ Do not leave the oven door open unnecessarily as someone may trip over it or be injured by it.
- ▶ The oven door can support a maximum load of 15 kg. Do not lean or sit on an open oven door, or place heavy items on it. Also make sure that nothing can get trapped between the door and the oven cavity. This could damage the oven.

Cleaning and care

- ▶ Do not use a steam cleaning appliance to clean this oven. Pressurised steam could reach the electrical components and cause a short circuit.
- ▶ Scratches on the door glass can result in the glass breaking. Do not use abrasive cleaners, hard sponges, brushes or sharp metal tools to clean the door glass.
- ▶ The shelf runners can be removed for cleaning purposes (see "Cleaning and care"). Ensure they are correctly fitted after cleaning and never operate the oven without the shelf runners fitted.
- ▶ The catalytic enamelled back panel can be removed for cleaning purposes (see "Cleaning and care"). Ensure it is correctly fitted after cleaning and never operate the oven without the back panel fitted.

Accessories

- ▶ Use only genuine original Miele spare parts. If spare parts or accessories from other manufacturers are used, the warranty will be invalidated, and Miele cannot accept liability.

Caring for the environment

Disposal of the packing material

The transport and protective packing has been selected from materials which are environmentally friendly for disposal and can normally be recycled.

Recycling the packaging reduces the use of raw materials in the manufacturing process and also reduces the amount of waste in landfill sites.

Rather than just throwing these materials away, please ensure they are offered for recycling.

Ensure that any plastic wrappings, bags, etc. are disposed of safely and kept out of the reach of babies and young children. Danger of suffocation!

Disposing of your old appliance

Electrical and electronic appliances often contain materials which, if handled or disposed of incorrectly, could be potentially hazardous to human health and to the environment. They are, however, essential for the correct functioning of your appliance. Therefore, please do not dispose of your old appliance with your household waste.

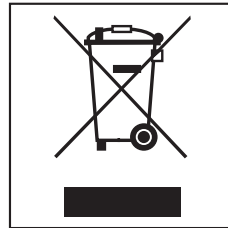

Please dispose of it at your local community waste collection / recycling centre.

Ensure that your old appliance presents no danger to children while being stored for disposal.

Oven overview

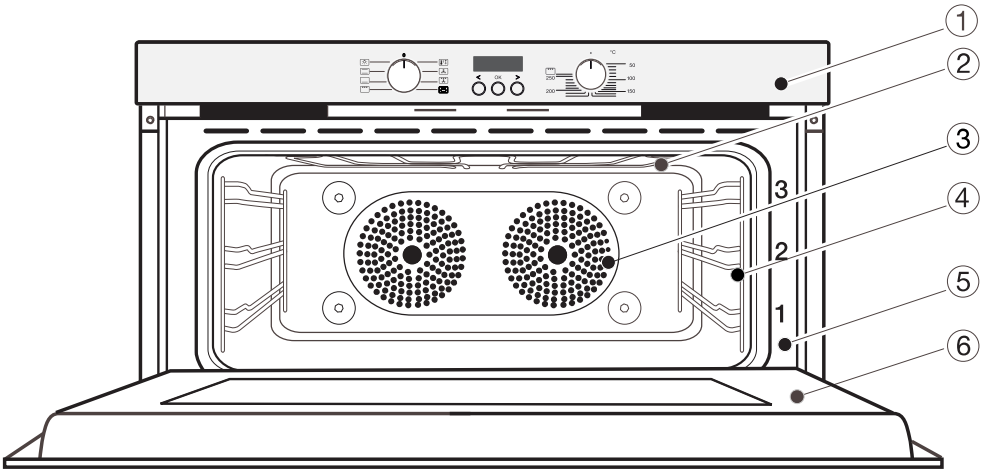

- ① Oven controls
- ② Top heat/grill element
- ③ Catalytic coated back panel with air inlets for the fans
- ④ Shelf runners with 3 shelf levels
- ⑤ Front frame with data plate
- ⑥ Door

Oven controls

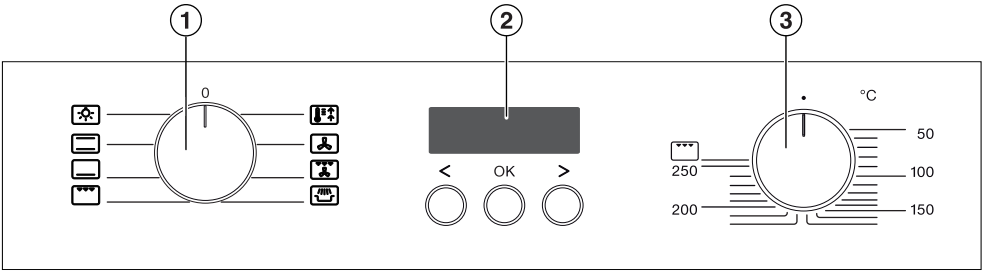

- ① Function selector
- ② Clock/Timer
- ③ Temperature selector







Function selector

The function selector is used to select oven functions and to switch on the oven lighting separately.

The function selector can be turned clockwise or anti-clockwise.

When the function selector is in the **0** position, it can be retracted by pushing it in.

Oven functions

-  Lighting
-  Conventional Heat
-  Bottom Heat
-  Grill
-  Rapid Heat-up
-  Fan Plus
-  Fan Grill
-  Gentle Bake

Temperature selector

Use the temperature selector to select the temperature for the cooking processes.

The temperature selector can be turned clockwise as far as it will go, and then back again.

When the temperature selector is in the ● position, it can be retracted by pushing it in.

The temperature settings are marked on the temperature selector and on the control panel.

Clock/Timer

The clock/timer is operated via the **display** with the <, OK and > **buttons**.

Display

The time of day or your settings appear in the display.

It goes dark if settings are not being entered.

Please refer to "Clock/Timer" for more information.

Buttons

This oven has push buttons.

Features

Model numbers

A list of the ovens described in these operating and installation instructions can be found on the back page of this booklet.

Data plate

The data plate located on the front frame of the oven is visible when the door is open.

On the data plate are printed the model number, serial number and the connection data (voltage/frequency/maximum rated load).

Have this information available if you need to contact Miele so that any issues can be rectified as quickly as possible.

Items supplied with delivery

Included in delivery are:

- the operating and installation instructions for using the oven functions,
- screws for fixing the oven to the housing unit,
- various accessories.

Standard and optional accessories

Depending on model!
All ovens are supplied with shelf runners, a universal tray and baking and roasting rack (rack for short).
Depending on the model, Miele ovens may be supplied with the accessories listed below.

All accessories and cleaning and care products in these instructions are designed to be used with Miele appliances.

They can be ordered at www.miele-shop.com (depending on country) or from Miele.

Please state the model number of your oven and that of any accessories you wish to purchase.

Shelf runners

Shelf runners for accessories (trays, racks, FlexiClip telescopic runners etc.) are fitted on either side of the oven cavity for shelf levels \square_1^3 .

The shelf level numbers are indicated on the front of the oven frame.

Each shelf runner has two rails:

- Accessories are inserted between the two shelf runners.
- FlexiClip telescopic runners (if available) are fitted to the bottom rail of each shelf runner.

The shelf runners can be removed for cleaning purposes (See "Cleaning and care").

Universal tray and rack with anti-tip safety notches

Universal tray:

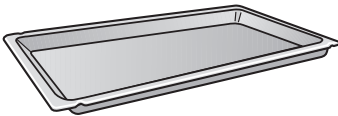

Rack:

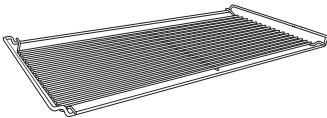

The universal tray and rack are inserted into the oven between the two rails of a shelf runner.

Always position the rack as illustrated above.

The universal tray and rack have anti-tip safety notches which prevent them being pulled right out when they only need to be partially pulled out.

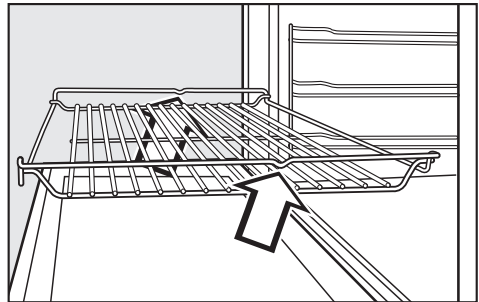
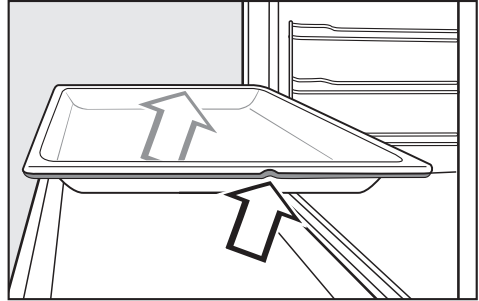

When pushing the rack back in, always ensure that the anti-tip safety notches are at the rear of the oven (see illustration).

They can then only be taken out of the oven by raising them upwards and then pulling them out.

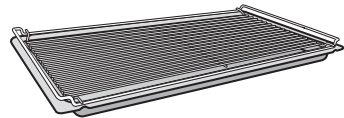

If you are using a tray with the rack on top, insert the tray between the rails of a shelf runner and the rack will sit on top of it.

Features

FlexiClip telescopic runners

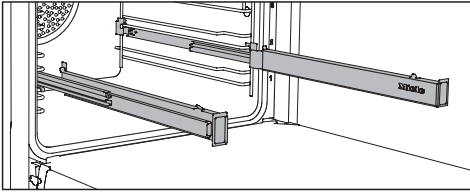

The FlexiClip telescopic runners can be attached to any shelf level.

Push the FlexiClip telescopic runners right into the oven before placing accessories on them. The accessories will then automatically sit securely in between the stoppers at either end of each runner and be prevented from sliding off.

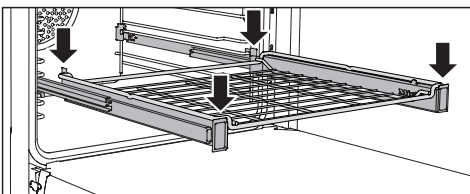
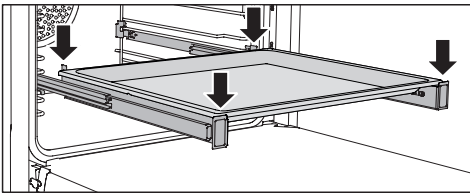

The maximum load for the FlexiClip telescopic runners is 15 kg.

Fitting and removing the FlexiClip telescopic runners

 Danger of burning!
Make sure the oven heating elements are switched off and the oven interior is cool.

The FlexiClip telescopic runners are fitted in between the two rails that make up a shelf level.

The telescopic runner with the Miele logo must be fitted on the right.

When fitting or removing the telescopic runners, do **not** extend them.

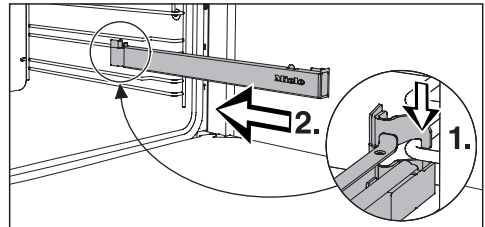

- Hook the FlexiClip telescopic runner onto the bottom rail of a shelf level at the front (1) and push it along the rail into the oven interior (2).

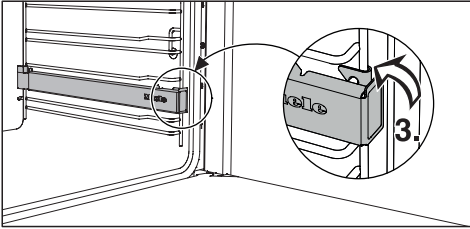

- Then secure the telescopic runner to the bottom of the two rails as illustrated (3).

If the telescopic runners are difficult to pull out after fitting, you may need to pull firmly on them once to release them.

To remove a FlexiClip telescopic runner:

- Push the FlexiClip telescopic runner all the way in.

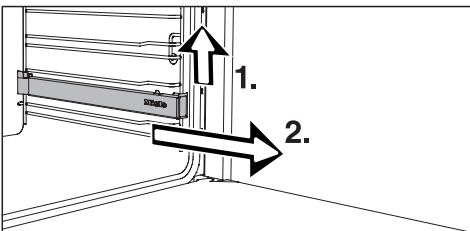

- Remove the FlexiClip runner by raising it at the front (1) then pulling it forwards along the rail and out (2).

Grilling and roasting insert

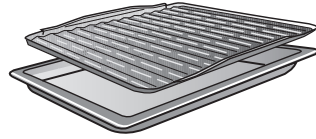

The grilling and roasting insert should be placed in the universal tray when grilling or roasting. The juices from the food being cooked collect under the insert. This prevents them from spitting and making the oven dirty. The juices can then be used for making gravy and sauces.

The surface has been treated with PerfectClean enamel.

Pizza tray HBF 27-1



This circular pan is suitable for cooking pizzas, flat cakes made with yeast or whisked mixtures, sweet and savoury tarts, baked desserts, and can also be used for frozen cakes.

The surface has been treated with PerfectClean enamel.

Features

Pizza stone HBS 60

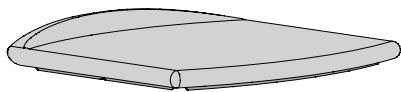

The pizza stone is ideal for items which need a well-baked base such as pizza, quiche, bread, bread rolls and savoury snacks.

The baking stone is made from heat retaining fire brick and is glazed.

Place it directly on the rack.

A wooden paddle is supplied with it for placing food on the pizza stone and taking it off.

Gourmet oven dishes HUB and lids HBD

The surface of the Miele Gourmet oven dishes has an anti-stick coating. It can be placed directly on the rack.

The oven dishes have depths of 22 cm or 35 cm. They have the same width and height.

Suitable lids are available separately.

Please quote the model number of your Miele oven dish when ordering a lid.

Depth: 22 cm

HUB61-22
HUB62-22*



HBD 60-22

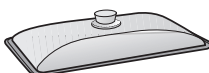

Depth: 35 cm

HUB 61-35**

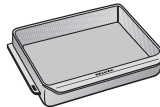

HBD 60-35

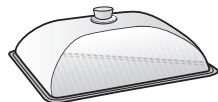

* Suitable for induction cooktops

** Oven dish HUB 61-35 cannot be used in conjunction with its lid because the total height of these two items exceeds the height of the oven cavity.

Catalytic enamelled liners

Back wall

Order this spare part if the catalytic enamel has become ineffective due to incorrect use or heavy soiling.

When ordering, please quote the model number of your oven.

Original Miele all purpose microfibre cloth

Light soiling and fingerprints can be easily removed with the microfibre cloth.

Original Miele oven cleaner

The Original Miele oven cleaner is suitable for removing very stubborn soiling from PerfectClean surfaces. It is not necessary to pre-heat the oven beforehand.

Oven controls

The oven controls enable you to use the various cooking functions to bake, roast and grill.

Ovens with a clock/timer also offer:

- a time of day display,
- a minute minder,
- a timer to automatically switch cooking programmes on and off,
- settings that can be customised.

Safety features

System lock for the oven

The system lock prevents the oven from being used unintentionally (see "Clock/Timer - Changing settings – P 3").

When the system lock is engaged,  will appear in the display.

Cooling fans

The cooling fans come on automatically when a cooking programme is started. The cooling fans mix hot air from the oven cavity with cool room air before venting it out into the kitchen through vents located between the appliance door and the control panel.

The cooling fans will continue to run for a while after a cooking process to prevent moisture building up in the oven, on the control panel or on the oven housing unit.

The fans will switch off automatically after a certain time.

Vented oven door

The door panes have a heat-reflective coating.

When the oven is operating, air is circulated through the door to keep the outer pane cool.

The door can be removed and dismantled for cleaning (see "Cleaning and care").

Features

PerfectClean treated surfaces

Surfaces treated with PerfectClean enamel are characterised by their exceptional non-stick properties and ease of cleaning.

Food can be taken off easily, and soiling from baking and roasting is simple to remove.

You can cut up food on surfaces treated with PerfectClean enamel.

However, do not use ceramic knives as these will scratch the PerfectClean surface.

Surfaces treated with PerfectClean enamel can be cleaned as you would clean glass.

Read the instructions in "Cleaning and care" so that the benefits of the non-stick properties and easy cleaning are retained.

The following have been treated with PerfectClean enamel:

- Oven interior
- Universal tray
- Grilling and roasting insert
- Pizza tray

Rear catalytic enamelled liner

The back panel is coated with catalytic enamel. Soiling from oil and fat is burnt off this surface when very high temperatures are used in the oven.

See "Cleaning and care" for more information.

Before using for the first time

 The oven must be built into its housing unit before it can be used.

- Press and release the function and temperature selectors if they are retracted.

The time of day can only be changed when the function selector is at **0**.

- Set the time of day on ovens with a clock/timer.

Setting the time of day for the first time

The time of day is shown in the 24-hour format.



After connecting the oven to the electricity supply, *12:00* flashes in the display.

The time of day is set in segments: first the hours, then the minutes.

- Press OK.

The hours will flash.

- Set the hours using < or >.

- Press OK.

The hours are saved and the minutes will flash.

- Set the minutes using < or >.

- Press OK.

The time of day is now saved.

The time of day can be displayed in 12-hour format by setting **P 2** in the settings menu to status *12* (see "Clock/Timer – Changing settings").

Using for the first time

Heating up the oven for the first time

New ovens can give off a slight smell on first use. Heating up the oven for at least 1 hour with nothing in it will get rid of this smell.

Ensure that the kitchen is well ventilated while the appliance is being heated up for the first time. Close doors to other rooms to prevent the smell spreading throughout the house.

- Remove any protective wrapping and sticky labels from the oven.
- Take all accessories out of the oven and clean them (see "Cleaning and care").
- Before heating up the oven, it is a good idea to wipe the interior out with a damp cloth first. This way any dust or bits of packaging that may have accumulated in the oven compartment during storage and unpacking will be removed.
- Select Fan Plus .

The oven heating, lighting and cooling fan will switch on.

- Select the maximum temperature (250 °C).
- Heat up the oven for at least 1 hour.
- At the end of the heating up time, turn the function selector to **0** and the temperature selector to ●.

 Danger of burning!
Allow the oven to cool down before cleaning by hand.

- Clean the oven interior with warm water, a little washing-up liquid and a clean sponge, or with a damp microfibre cloth.
- Dry all surfaces with a soft cloth.

Leave the oven door open until the oven interior is completely dry.

Overview of functions

Your oven has a range of functions for preparing a wide variety of recipes.

Depending on the function selected, different heating elements are switched on and sometimes combined with the fan (see details in parentheses).

Conventional Heat

(Top heat/grill element + bottom heat element)

For baking and roasting traditional recipes, preparing soufflés and cooking at low temperatures.

If using an older recipe or cookbook, set the oven temperature for Conventional Heat 10 °C lower than that recommended. This won't change cooking times.

Bottom Heat

(Bottom heat element)

Use this function towards the end of cooking to reheat or brown the base of a cake, quiche or pizza.

Grill

(Top heat/grill element)

For grilling and toasting bread, open sandwiches etc. and browning baked dishes.

Rapid Heat-up

(Top heat/grill element + ring heat element + fan)

For pre-heating the oven compartment quickly.

The oven function required must then be selected once the desired temperature has been reached.

Fan Plus

(Ring heat element + fan)

This function is used for baking and roasting on different levels at the same time.

A lower temperature can be selected than when using Conventional Heat , as the fans distribute the heat to the food straight away.

Fan Grill

(Top heat/grill element + fan)

For grilling thicker cuts of meat (e.g. roulades, chicken). Lower temperatures can be used than when using the Grill  function, as the fans distribute the heat to the food straight away.

Gentle Bake



(Ring heat element + fan)

For cooking meat.

The oven lighting does not switch on with this function.

Tips on saving energy

Cooking

- Remove any accessories from the oven that you do not require for cooking.
- Pre-heat the oven only if instructed to do so in the recipe or the cooking chart.
- Avoid opening the door during cooking.
- In general, if a range of temperatures is given, it is best to select the lower temperature and to check the food after the shortest given time.
- It is best to use dark baking tins and containers with a matt finish made from non-reflective materials (enamelled steel, ovenproof glassware, non-stick coated cast aluminium). Shiny materials such as stainless steel or aluminium reflect heat, preventing it reaching the food efficiently. Do not cover the oven floor or the rack with heat-reflective aluminium foil.
- Observe cooking durations to avoid energy wastage when cooking food.
Wherever possible set the cooking duration, or use a food probe.
- Fan Plus  can be used for cooking many types of food. Because the fan distributes the heat to food straight away, it allows you to use a lower temperature than you would with Conventional Heat . It also enables you to cook on several shelf levels at the same time.
- Fan Grill  can be used for a wide variety of food. With Fan Grill you can use lower temperatures than with other grill functions which use the maximum temperature setting.
- Whenever possible you should cook several dishes at the same time. Place them next to each other in the oven or on different shelf levels.
- Dishes which you are unable to prepare at the same time should, if possible, be cooked one after the other in order to make use of existing heat in the oven.

Using residual heat

- The temperature in cooking programmes using temperatures above 140 °C which take longer than 30 minutes to cook can be turned down to the lowest possible temperature about 5 minutes before the end of cooking in order to make use of residual heat. The cooling fans and, depending on cooking function, the hot air fans will remain on. Do not switch the oven off (see "Safety instructions").
- If you wish to clean catalytic enamelled parts of the oven, it is best to do so immediately after a cooking programme. The residual heat in the oven will help reduce the amount of energy required. Before cleaning any catalytic parts of the oven, ensure you clean the door and PerfectClean surfaces first to avoid soiling baking on.

Operation

Using the oven

- Unless the recipe requires a pre-heated oven, place the food in the oven.
- Select the required oven function with the function selector.

The oven lighting and the fans will switch on.

- Select the temperature with the temperature selector.

The oven heating is switched on and the temperature indicator light  lights up in the display next to the time of day:



The temperature indicator light  lights up whenever the oven heating is switched on.

As soon as the set temperature is reached,

- the oven heating switches off,
- the temperature indicator light goes out.

The temperature regulator ensures that the oven heating and temperature indicator light switch back on again when the oven temperature falls below the level set.

After the cooking process:

- Turn the function selector to **0** and the temperature selector to **●**.
- Remove the food from the oven.

Cooling fans

The cooling fans will continue to run for a while after the oven has been switched off to prevent any humidity building up in the oven, on the control panel or in the oven housing unit.

The fans will switch off automatically after a certain time.

Pre-heating

It is only necessary to pre-heat the oven in a few instances.

Most dishes can be placed in a cold oven. They will then make use of the heat produced during the heating-up phase. If the recipe requires pre-heating, place the food in the oven once the temperature indicator light goes out.

Pre-heat the oven when cooking the following food with the following oven functions:

Fan Plus



- dark bread doughs,
- beef sirloin joints and fillets.

Conventional Heat

- cakes or biscuits with a short baking time (up to 30 minutes),
- delicate mixtures (e.g. sponges),
- dark bread doughs,
- beef sirloin joints and fillets.

Rapid Heat-up

Do not use Rapid Heat-up  to pre-heat the oven when baking pizzas or delicate mixtures (e.g. small baked goods with a high sugar content, pizza, choux pastries, sponges). They will brown too quickly.

- Select Rapid Heat-up .
- Select a temperature.
- When the temperature indicator light  goes out for the first time, set the oven function you require for continued cooking or baking.
- Unless the recipe requires a pre-heated oven, place the food in the oven.

Clock/Timer

The clock/timer:

- displays the time of day,
- can be used as a minute minder,
- can switch cooking programmes on or off,
- can be used to change various settings *P*.

The clock/timer is operated via the **display** with the <, OK and > **buttons** .

The functions available are indicated by symbols.

Display



Symbols in the display

Depending on the position of the function selector \bigcirc and/or which button is pressed, the following symbols will appear:

Symbol/Function	\bigcirc
Minute minder	Any
Duration	Oven function
End of cooking duration	
Temperature indicator light	
<i>P</i> Setting	0
5 Setting status	
System lock	

You can only set or change a function if the function selector is in the correct position.

Buttons

Button	Use
<	<ul style="list-style-type: none">– Calling up functions– Highlighting functions– Reducing times– Calling up settings <i>P</i>– Changing the status 5 of a setting <i>P</i>
>	<ul style="list-style-type: none">– Calling up functions– Highlighting functions– Increasing times– Changing the status 5 of a setting <i>P</i>
OK	<ul style="list-style-type: none">– Calling up functions– Saving set times and adjusted settings– Calling up set times

Hours, minutes or seconds are set with the < or > buttons in individual steps. Holding the button pressed will speed up the change in the display.

How to set the time or a duration

Times are set in segments:

- For the time of day and cooking durations, first the hours, then the minutes.
- For the minute minder, first the minutes, then the seconds.

- Press any button.

Depending on the position of the function selector, the functions (⏰, ⌚, ⌚) will appear.

- Highlight the required function using < or >.

The corresponding symbol flashes for approx. 15 seconds.

- Press OK while the symbol is flashing.

The function is selected and the left numeric block will start to flash.

You can only set the time/duration while the numeric block is flashing. If the symbol has stopped flashing, you will need to select the function again.

- Set the required value using < or >.
- Press OK.

The right numeric block will start to flash.

- Set the required value using < or >.
- Press OK.

Your time/duration setting is now saved.

Displaying times/durations

If you have set times, the symbols ⏰ and ⌚ or ⌚ indicate which time functions have been set.

If you are using the minute minder ⏰, cooking duration ⌚ and end of cooking time ⌚ functions simultaneously, the last selected time will be displayed.

If you have selected a cooking duration, the time of day cannot be displayed.

When the time/duration has elapsed

- the relevant symbol will flash,
- a buzzer will sound, if this option is selected (see "Clock/Timer - Changing settings").

- Press OK.

The buzzer will stop and the symbols in the display will go out.

Clock/Timer

Using the minute minder

The minute minder can be used to time other activities in the kitchen, e.g. boiling eggs.

The minute minder can also be used at the same time as a cooking programme for which the start and finish times have been set, e.g. as a reminder to stir a dish or add seasoning etc.

A maximum minute minder time of 99 minutes and 59 seconds can be set.

Setting the minute minder

Example:

You want to boil some eggs and set a minute minder time of 6 minutes and 20 seconds.



- Press < repeatedly until  starts flashing.
- Press OK.



- **00:00** appears and the minutes will flash.

If you then press < once, two lines will appear and, after pressing again, the maximum possible minute value (**99**) will appear.



- Set the minutes using < or >.
- Press OK.

The minutes are saved and the seconds will flash.



- Set the seconds using < or >.
- Press OK.



The minute minder is saved and will count down in seconds.

The  symbol indicates the minute minder has been set.

At the end of the minute minder time

- 🔔 flashes,
- the time will count upwards,
- a buzzer will sound for approx. 7 minutes, if this option is selected (see "Clock/Timer - Changing settings").

- Press OK.

The buzzer will stop and the symbols in the display will go out.

If cooking durations have not been set, the time of day will appear in the display.

To change the time set for the minute minder

- Press < repeatedly until 🔔 starts flashing.

The minute minder time selected appears.

- Press OK.

The minutes will flash.

- Set the minutes using < or >.

- Press OK.

The seconds will flash.

- Set the seconds using < or >.

- Press OK.

The changed minute minder is saved and will count down in seconds.

To cancel the time set for the minute minder

- Press < repeatedly until 🔔 starts flashing.

- Press OK.

The minutes will flash.

- Decrease the minutes to **00** by pressing <, or increase them to **99** by pressing >.

The next time the relevant button is pressed, two lines will appear instead of the minutes:



- Press OK.

Four lines will appear:



- Press OK.

The minute minder is now cancelled.

If cooking durations have not been set, the time of day will appear in the display.

Clock/Timer

Switching cooking programmes on and off automatically

Cooking programmes can be switched on or off automatically.

To do this, set a duration or a duration and finish time after selecting an oven function and a temperature.

The maximum duration which can be set for a cooking programme is 11 hours and 59 minutes.

We recommend using automatic switching on and off when roasting. However, do not delay the start for too long when baking as the cake mixture or dough will dry out, and the raising agents will lose their effectiveness.

Setting a cooking duration

Example:

A cake requires 1 hour and 5 minutes baking time.

- Unless the recipe requires a pre-heated oven, place the food in the oven.
- Select the required oven function and the temperature.

The oven heating, lighting and cooling fans will switch on.

- Press > repeatedly until  starts flashing.



00:00 will appear.

- Press OK.



00:00 appears and the hours will flash.

If you then press < once, two lines will appear and, after pressing again, the maximum possible hour value (##) will appear.



- Set the hours using < or >.
- Press OK.

The hours are saved and the minutes will flash.



- Set the minutes using < or >.
- Press OK.



The cooking duration is saved and then counts down in minutes, with the last minute counting down in seconds.

The  symbol indicates a cooking duration has been set.

At the end of the cooking duration

- **00:00** appears,
-  starts to flash,
- the oven heating switches off automatically,
- the cooling fans remain switched on,
- a buzzer will sound for approx. 7 minutes, if this option is selected (see "Clock/Timer - Changing settings").

- Press OK.

As soon as you press OK,

- the buzzer will stop and the symbols in the display will go out.
- the time of day will appear,
- the oven heating will switch back on.

- Turn the function selector to **0** and the temperature selector to **●**.
- Remove the food from the oven.

Clock/Timer

Setting a cooking duration and finish time

A cooking duration and finish time can be set to switch a cooking programme on and off automatically.

Example:

The time is now 11:15 ;
you want a dish with a cooking duration of 90 minutes to be ready by 13:30 .

- Unless the recipe requires a pre-heated oven, place the food in the oven.
- Select the required oven function and the temperature.

The oven heating, lighting and cooling fans will switch on.

Set the cooking duration first:

- Press > repeatedly until  starts flashing.
- Press OK.

00:00 appears and the hours will flash.

- Set the hours using < or >.
- Press OK.

The hours are saved and the minutes will flash.

- Set the minutes using < or >.
- Press OK.

The cooking duration is now saved.



The  symbol indicates a cooking duration has been set.

Then set the finish time:

- Press > repeatedly until  starts flashing.



- 12:45 will appear in the display (= current time of day + cooking duration = 11:15 + 1:30).

- Press OK.

The hours will flash.



- Set the hours using < or >.
- Press OK.

The hours are saved and the minutes will flash.



- Set the minutes using < or >.
- Press OK.

The finish time  is now saved.

The oven heating, lighting and cooling fans will switch off.

The selected finish time appears in the display.

As soon as the start time (*13:30 - 1:30 = 12:00*) is reached, the oven heating, lighting and cooling fans will switch on.

The set cooking duration  appears and then counts down in minutes, with the last minute counting down in seconds.

Changing the cooking duration

- Press < or > repeatedly until  starts to flash.

The remaining cooking duration appears in the display.

- Press OK.

The hours will flash.

- Set the hours using < or >.

- Press OK.

The minutes will flash.

- Set the minutes using < or >.

- Press OK.

The changed cooking duration is now saved.

Clock/Timer

Deleting a cooking duration

- Press < or > repeatedly until  starts to flash.

- Press OK.

The hours will flash.

- Press < or > repeatedly until two lines appear:



- Press OK.

Four lines will appear:



- Press OK.

The cooking duration and any finish time will be deleted.

The time of day appears if no minute minder has been set.

The oven heating, lighting and cooling fans will switch on.

If you want to finish the cooking programme:

- Turn the function selector to **0** and the temperature selector to **●**.
- Remove the food from the oven.

Deleting a finish time

- Press < or > repeatedly until  starts to flash.

- Press OK.

The hours will flash.

- Press < or > repeatedly until two lines appear.

- Press OK.

Four lines will appear:



- Press OK.

The  symbol appears and the cooking duration counts down in minutes, with the last minute counting down in seconds.

If you want to finish the cooking programme:

- Turn the function selector to **0** and the temperature selector to **●**.
- Remove the food from the oven.

If you turn the function selector to **0**, the settings for the cooking duration and the finish time will be deleted.

Changing the time of day

The time of day can only be changed when the function selector is at **0**.

- Turn the function selector to **0**.
- Press and hold the < and > buttons together.

The hours will flash.

- Set the hours using < or >.
- Press OK.

The hours are saved and the minutes will flash.

- Set the minutes using < or >.
- Press OK.

The time of day is now saved.

After a power cut, the time of day needs to re-entered.

Clock/Timer

Changing settings

Your appliance is supplied with a number of standard default settings (see the "Settings overview" chart).

A setting *P* can be changed by altering its status *S*.

- Turn the function selector to **0**.
- Press and hold < until *P* / appears.



- If you want to change another setting, press < or > repeatedly until the relevant number appears.
- Press OK.



- The setting is selected and the current status *S* appears, e.g. *0*.

To change the status:

- Press < or > repeatedly until the required status appears in the display.
- Press OK.

The selected status is saved and the setting *P* appears again.

If you want to change further settings, proceed as described above.

If you do not want to change any further settings:

- Wait approx. 15 seconds until the time of day appears.

The settings remain in the memory even after a power cut.

Settings overview



Setting	Status
<p><i>P 1</i></p> <p>Buzzer volume</p>	<p><i>S 0</i> The buzzer is switched off.</p> <p><i>S 1</i> to The buzzer is switched on.*</p> <p><i>S 30</i> The volume can be altered. When you select a status, you will hear the corresponding buzzer.</p>
<p><i>P 2</i></p> <p>Clock format</p>	<p><i>24*</i> The time of day is shown in the 24-hour format.</p> <p><i>12</i> The time of day is shown in the 12-hour format.</p> <p>If you change the clock after 1 pm (13:00) from a 12-hour clock to a 24-hour clock, you will need to update the hours for the time of day accordingly.</p>
<p><i>P 3</i></p> <p>System lock for the oven</p>	<p><i>S 0*</i> The system lock is switched off.</p> <p><i>S 1</i> The system lock is switched on and  appears in the display.</p> <p>The system lock prevents the oven from being used unintentionally, by children for example.</p> <p>The system lock remains active even after a power cut.</p>

* Factory default setting

Baking



Eating food which has been cooked correctly is important for preventing food poisoning or other ailments. Only bake cakes, pizza, chips etc. until they are golden brown. Do not overcook them.

Oven functions

Depending on how the food is prepared, you can use either Fan Plus  or Conventional Heat .

Bakeware

The choice of bakeware depends on the oven function and how the food is prepared.

- Fan Plus :
Baking tray, universal tray, bakeware of any ovenproof material.
- Conventional Heat :
Dark baking tins with a matt finish. Avoid using bright, shiny metal tins as they give an uneven and poor browning result and in some cases cakes might not cook properly.

- Always place baking tins on the rack.

Position rectangular tins with the longer side across the width of the rack for optimum heat distribution and even baking results.

- When baking cakes with fresh fruit toppings and deep sponge cakes, place the tin on the universal tray to catch any spillages and keep the oven cleaner.

Baking paper, greasing

Miele accessories, e.g. the universal tray, are treated with PerfectClean enamel (see "Features").

Surfaces treated with PerfectClean enamel generally do not need to be greased or covered with baking paper.

Baking paper is only needed with

- anything with a high salt content (e.g. pretzels, bread sticks), because sodium can damage the PerfectClean surface;
- meringues or sponges with a high egg-white content, because they are more likely to stick;
- frozen food cooked on the rack.

Notes on the baking chart

Temperature 🌡️

As a general rule, select the lower temperature given in the chart.

Baking at temperatures higher than those recommended may reduce the cooking time, but will lead to uneven browning, and unsatisfactory cooking results.

Baking time ⌚

Check if the food is cooked at the end of the shortest time quoted.

To check if a cake is ready, insert a wooden skewer into the centre. It is ready if the skewer comes out clean, without dough or crumbs sticking to it.

Shelf levels 📏³

The shelf level on which you place your food for baking depends on the oven function and number of trays being used.

- Fan Plus 🌀
1 tray: Shelf level 1
2 trays: Shelf levels 1+3

The universal tray should be placed underneath the baking tray if you are using a universal tray and a baking tray on several levels at the same time.

Bake moist biscuits and cakes on a maximum of two levels at the same time.

- Conventional Heat 📏
1 tray: Shelf level 1 or 2

Baking









Baking chart

Cakes/Biscuits
Creamed mixture
Sand cake
Ring cake
Muffins (1 tray)
Small cakes (1 tray) ¹⁾
Small cakes (2 trays) ¹⁾
Foam cake (tray)
Marble, nut cake (tin)
Fresh fruit cake, with meringue topping (tray)
Fresh fruit cake (tray)
Fresh fruit cake (tin)
Flan base
Small cakes/Biscuits (1 [2] tray(s))
Rubbed in mixture
Flan base
Streusel cake
Small cakes/Biscuits (1 [2] tray(s))
Drop cookies (1 [2] tray(s)) ¹⁾
Cheese cake
Apple pie (tin Ø 20 cm) ¹⁾
Apple tart ¹⁾
Fresh fruit tart, glazed (tin)
Swiss apple pie (tray)

The data for the recommended function is printed in bold.

Unless otherwise stated, the times given are for an oven which has not been pre-heated. With a pre-heated oven, shorten times by up to 10 minutes.

In general, if a range of temperatures is given, it is best to select the lower temperature and to check the food after the shortest time.

					
 [°C]	 1 ³	 [min.]	 [°C]	 1 ³	 [min.]
150–160	2	65–75	150–160 ²⁾	2	65–75
150–160	1	60–70	170–180	1	60–80
140–160	2	30–50	150–170	2	35–45
150–170 ²⁾	1	20–30	160–180 ²⁾	2	18–25
140–160	1+3	40–50	–	–	–
140–160 ²⁾	1	20–30	150–170	1	30–40
150–160	1	55–65	150–160	1	60–70
150–160	1	40–50	170–180	1	40–50
150–160	1	30–40	160–170	1	40–50
150–160	1	55–65	170–180 ²⁾	1	50–60
150–160	1	25–35	170–180 ²⁾	1	15–25
140–160	1 [1+3 ³⁾	25–35 [30–40]	150–170 ²⁾	2	15–20
150–160	1	35–45	170–180 ²⁾	2	20–30
150–160	1	45–55	170–180	2	45–55
140–160	1 [1+3 ³⁾	20–30	160–180 ²⁾	2	15–25
140	1 [1+3 ³⁾	35–45	160 ²⁾	2	20–30
140–160	1	75–85	150–170	1	95–105
160	1	85–95	170	1	95–105
160–170	1	50–70	170–180 ²⁾	1	50–70
150–160	1	50–70	170–180	1	50–70
–	–	–	220–230 ²⁾	1	30–50

 Fan Plus /
  Conventional Heat /
  Intensive Bake

 Temperature /
  ³ Shelf level /
  Baking time

1) The settings also apply for testing in accordance with EN 60350.

2) Pre-heat the oven, but do not use Rapid Heat-up .

3) Take the baking trays out of the oven early if the food is sufficiently browned before the specified time has elapsed.

Baking









Baking chart

Cakes/Biscuits
Whisked mixture
Tart / flan base (2 eggs)
Sponge cake (4 to 6 eggs)
Whisked sponge cake ¹⁾
Swiss roll
Yeast mixtures and quark dough
Proving yeast dough
Gugelhupf
Stollen
Streusel cake
Fresh fruit cake (tray)
White bread
Wholegrain bread
Pizza (tray)
Onion tart
Apple turnovers (1 [2] tray(s))
Choux pastry, Eclairs (1 [2] tray(s))
Puff pastry (1 [2] tray(s))
Meringues, (1 [2] tray(s))

The data for the recommended function is printed in bold.

Unless otherwise stated, the times given are for an oven which has not been pre-heated. With a pre-heated oven, shorten times by up to 10 minutes.

In general, if a range of temperatures is given, it is best to select the lower temperature and to check the food after the shortest time.

					
 [°C]	 3 1	 [min.]	 [°C]	 3 1	 [min.]
160–170	1	20–30	160–170 ²⁾	1	15–25
160–180	1	20–35	150–170 ²⁾	1	30–45
170	1	20–30	150–170 ²⁾	1	20–30
160–170 ²⁾	1	18–25	160–170 ²⁾	2	10–15
35	³⁾	15–30	35	³⁾	15–30
150–160	1	45–55	160–170	1	50–60
150–160	1	45–65	160–170	1	45–60
150–160	2	35–45	170–180	2	35–45
160–170	2	40–60	170–180	2	40–60
180–190	1	35–45	190–200	1	30–40
180–190	1	55–65	200–210 ²⁾	1	45–55
220–240	2	10–20	220–240 ²⁾	2	10–25
170–180	2	30–40	180–190 ²⁾	2	25–35
150–160	2 [1+2 ⁴⁾]	25–30	160–170	2	25–30
160–170	1 [1+2 ⁴⁾]	30–45	180–190 ²⁾	2	25–35
170–180	2 [1+3 ⁴⁾]	20–30	190–200 ²⁾	2	20–30
120–130	2 [1+3 ⁴⁾]	25–50	120–130 ²⁾	2	25–45



 Fan Plus /  Conventional Heat /  Intensive Bake

 Temperature /  Shelf level /  Baking time

- 1) The settings also apply for testing in accordance with EN 60350.
- 2) Pre-heat the oven, but do not use Rapid Heat-up .
- 3) Place the rack on the floor of the oven, and stand the bowl containing the dough on the rack.
- 4) Take the baking trays out of the oven early if the food is sufficiently browned before the specified time has elapsed.

Roasting

Oven functions

Depending on how the food is prepared, you can use either Fan Plus  or Conventional Heat .

Roasting dishes

You can use any heat-resistant crockery:

Miele Gourmet oven dishes, roasting pans, ovenproof glass trays, roasting bags, dishes made from earthenware or cast iron, the universal tray, rack and/or grilling and roasting insert (if available) on top of the universal tray.

We recommend roasting in covered oven dishes as this ensures that sufficient stock remains for making gravy.



The oven also stays cleaner than with open roasting.

Notes on the roasting chart

Temperature

As a general rule, select the lower temperature given in the chart.

If higher temperatures are used, the meat will brown on the outside, but will not be properly cooked through.

When cooking with Fan Plus , select a temperature 20 °C lower than when using Conventional Heat .

Select a temperature of approx. 10 °C lower than quoted in the roasting chart for meat weighing more than 3 kg. The roasting process will take longer, but the meat will cook evenly through and the skin or crackling will not be too thick.

When roasting on the rack, set a temperature approx. 10 °C lower than if using an oven dish.

Pre-heating

Pre-heating is only required when roasting beef sirloin joints and fillets.

Roasting duration ⊕

The roasting time can be determined by multiplying the thickness of the roast [cm] with the time per cm [min./cm] stated below, depending on the type of meat:

Beef/Venison: 15–18 min./cm

Pork/Veal/Lamb: 12–15 min./cm

Sirloin joints/Fillets: 8–10 min./cm

Check if the meat is cooked after the shortest time quoted.

Shelf levels

Use shelf level 1 or 2 depending on the height of the food.

Useful tips

Browning

Browning only occurs towards the end of the roasting time. If cooking with a roasting dish, remove the lid about halfway through the roasting time if a more intensive browning result is desired.

Standing time

At the end of the programme, take the roast out of the oven, wrap in aluminium foil and leave to stand for about 10 minutes. This helps retain juices when the meat is carved.

Roasting poultry

For a crisp finish, baste the poultry 10 minutes before the end of the cooking time with slightly salted water.

Roasting

Roasting chart

Meat/Fish
Topside of beef, approx. 1 kg
Fillet of beef, approx. 1 kg ¹⁾
Sirloin joint, approx. 1 kg ¹⁾
Poultry, 0.8–1 kg
Poultry, approx. 2 kg
Poultry, stuffed, approx. 2 kg
Poultry, approx. 4 kg
Venison, approx. 1 kg
Pork roast/neck, approx. 1 kg
Pork joint with crackling, approx. 2 kg
Gammon joint, approx. 1 kg
Meat loaf, approx. 1 kg
Veal, approx. 1.5 kg
Leg of lamb, approx. 1.5 kg
Saddle of lamb, approx. 1.5 kg
Fish, whole, approx. 1.5 kg

The data for the recommended function is printed in bold.







Unless otherwise stated, the times given are calculated on the basis of an oven which has not been pre-heated.

As a general rule, use shelf level 1.

In general, if a range of temperatures is given, it is best to select the lower temperature and to check the food after the shortest time.

Temperatures refer to cooking in an uncovered dish.

If roasting directly on the universal tray or the rack, set the temperature to 10 °C lower.

			
 [°C]	 [min.]	 [°C]	 [min.]
170–180	100–130 ³⁾	190–200	110–140 ³⁾
150–160 ²⁾	20–50 ⁴⁾	180–190 ²⁾	20–50 ⁴⁾
150–160 ²⁾	30–60 ⁴⁾	180–190 ²⁾	30–60 ⁴⁾
180–190	60–70	190–200	60–70
170–180	100–120	190–200	110–130
170–180	110–130	190–200	120–140
160–170	120–160 ⁵⁾	180–190	120–160 ⁵⁾
200–210	80–100 ³⁾	200–210	80–100 ³⁾
160–170	130–150 ⁵⁾	180–190	130–150 ⁵⁾
170–180	120–160 ⁵⁾	190–200	130–150 ⁵⁾
150–160	60–80 ⁵⁾	170–180	80–100 ⁵⁾
170–180	60–70 ⁵⁾	200–210	70–80 ⁵⁾
190–200	70–90 ³⁾	200–210	90–110 ³⁾
170–180	90–110 ³⁾	180–190	90–110 ³⁾
220–230 ²⁾	40–60 ⁵⁾	230–240 ^{2) 6)}	40–60 ⁵⁾
160–170 ⁶⁾	45–55	180–190 ⁶⁾	45–55

 Fan Plus /  Conventional Heat

 Temperature /  Shelf level /  Roasting time

- 1) Use the universal tray. First sear the meat all over on the cooktop to seal it.
- 2) Pre-heat the oven, but do not use Rapid Heat-up .
- 3) Roast with the lid on first, then remove the lid halfway through roasting and pour over approx. 0.5 litre liquid.
- 4) Depending on the degree of cooking required (when using a food probe): rare: 40–45 °C, medium: 50–60 °C, well done: 60–70 °C
- 5) Pour over approx. 0.5 litre liquid halfway through roasting.
- 6) Use shelf level 2.

Low temperature cooking

This programme is ideal for cooking beef, pork, veal or lamb when a tender result is required.

First the meat needs to be seared all over briefly at a high temperature on the cooktop in order to seal it.

Then place the meat in the pre-heated oven where the low temperature and long cooking time will cook it to perfection and ensure it is very tender.

The meat relaxes and the juices inside start to circulate evenly throughout the meat to reach the outer layers. This has very tender and succulent results.

Useful tips

- Use lean meat which has been correctly hung and trimmed. Bones should be removed before cooking.
- For searing, use a suitable cooking oil or fat that can withstand high temperatures (e.g. clarified butter).
- Do not cover meat during cooking.

The cooking duration is approx. 2–4 hours and depends on the weight and size of the meat, as well as the desired degree of doneness and browning.

Low temperature cooking procedure

Use the universal tray with the rack placed on top of it.

Do not use the Rapid Heat-up  function to pre-heat the oven.

- Place the rack together with the universal tray on shelf level 1.
- Select Conventional Heat  and a temperature of 130 °C.
- Pre-heat the oven together with the universal tray and rack for approx. 15 minutes.
- While the oven is pre-heating, sear the meat on all sides on the cooktop.

 **Danger of burning!**
Use oven gloves when placing food in the oven, turning or removing it and when adjusting oven shelves etc. in a hot oven.

- Place the seared meat on the rack.
- Reduce the temperature to 100 °C.
- Continue cooking until the end of the cooking duration.

Low temperature cooking

After cooking

Because the cooking and core temperatures are very low:

- Meat can be carved straight from the oven. It does not need to rest.
- The cooking result won't be affected if the meat is left in the oven after the finish of the programme. It can be kept warm until you serve it.
- The meat is at an ideal temperature to be eaten straight away. Serve on pre-heated plates with very hot sauce or gravy to prevent it cooling down too quickly.

Cooking durations/Core temperatures

Meat	Duration [min.]	Core-temperatur** [°C]
Sirloin joint		
– Rare	60–90	55–60
– Medium	120–150	65–70
– Well-done	180–240	70–75
Pork fillet	120–150	65–80
Gammon*	150–210	75–80
Saddle of veal*	180–210	65–75
Saddle of lamb*	90–120	65–75

* Boned

** Use a food probe if you need to monitor the increase in the core temperature.

Grilling



Danger of burning!

Grill with the oven door closed. If you grill with the door open, hot air will escape from the oven instead of being cooled by the cooling fan. The controls will get hot.

Oven functions

Grill

For grilling and toasting bread, open sandwiches etc. and browning baked dishes.

The top heat/grill element is ready for use when it glows red.

Fan Grill

For grilling thicker items, e.g. rolled meat, poultry pieces.

The top heat/grill element and fan are switched on alternately.

Grilling dishes

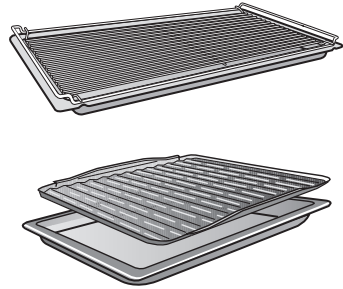

Use the universal tray with the rack or grilling and roasting insert (if available) on top.

The juices from the food being cooked collect under the insert. This prevents them from spitting and making the oven dirty. The juices can then be used for making gravy and sauces.

Notes on the grilling chart

Temperature

As a general rule, select the lower temperature given in the chart. If higher temperatures are used, the meat will brown on the outside, but will not be properly cooked through.

The  setting is recommended for toasting and the fast browning of lean items.

Pre-heating

Always pre-heat the top heat/grill element for approx. 5 minutes with the door closed.

Shelf levels

Select the shelf level according to the thickness of the food.

- Thin cuts: Shelf levels 2/3
- Thicker cuts: Shelf levels 1

Grilling duration

- Turn the food halfway through the cooking time.

Testing to see if cooked

One way of finding out how far through a piece of meat has been cooked is to press down on it with a spoon:

- Rare: If there is very little resistance to the pressure of the spoon, it will still be red on the inside.
- Medium: If there is some resistance, the inside will be pink
- Well-done: If there is great resistance, it is cooked through.

Check if the meat is cooked after the shortest time quoted.

Tip

If the surface of thicker cuts of meat is cooked but the centre is still raw, continue grilling at a lower temperature setting or use a lower shelf level to allow the food to cook through to the centre. This will also prevent the surface of the meat getting too dark.

Grilling

Preparing food for grilling

Rinse meat under cold running water and then pat dry. Do not season meat with salt before grilling as this draws the juices out.

Add a little oil to lean meat if necessary. Do not use other types of fat as they can burn and cause smoke.

Clean fish in the normal way. To enhance the flavour, add a little salt or squeeze a little lemon juice over the fish.

Grilling

- Place the rack or the roasting and grilling insert (if available) in the universal tray.
- Place the food on top.
- Select the required oven function and the temperature.
- Pre-heat the top heat/grill element for approx. 5 minutes with the door closed.

 **Danger of burning!**
Use oven gloves when placing food in the oven, turning or removing it and when adjusting oven shelves etc. in a hot oven.

- Place the food on the appropriate shelf level (see Grilling guide).
- Close the door.
- Turn the food halfway through grilling.

Fan Grilling guide (Fan Grill)

- Use the Fan Grill function for meat, fish, poultry and vegetables.
- Always pre-heat to desired temperature before Fan Grilling.
- It is not necessary to turn food when Fan Grilling.
- The door must be closed during Fan Grilling.
- When using red meat, pat the meat dry before Fan Grilling as this encourages a richer colour.
- Note: all temperatures are approximations and must be varied according to the thickness and preparation of the meat. The chart below is a suggested guide only. Personal taste and size of serves will vary times and temperatures. We recommend you monitor cooking results for best outcomes.

Fan Grill: Food	Temperature in °C	Shelf level	Total grilling time in min.
Lean thin sausages	180	3	8–10
Thick sausages	180	2–3	15–20
Lean scotch fillet steak	220	3	6–12
Chicken breast fillet, plain or a dry marinade	200	3	14–18
Chicken breast fillet, with a wet marinade	200	3	14–18
Whole butterflied chicken	200	1	30–35
Thin white fish fillets (in universal tray)	220	3	6–10
Thick fish fillets, cutlets or steaks (on grilling and roasting insert placed in the universal tray)	200	3	10–15
Oily fish (on grilling and roasting insert placed in the universal tray)	200	3	8–12
Lamb loin chops	190	3	12–16
Lamb back straps	220	3	8–10
Vegetables, capsicum, zucchini, sweet potato, eggplant	200	3	12–15
Potato wedges or small roast potatoes	190–220	2	20–25
Kebabs and satays (red meat)	200	3	12–15
Chicken satays	200	3	12–15

Fan Grilling can be used for small roasts but is only recommended for lean, tender cuts of meat, like lamb racks, rump roasts, and beef fillet. Fan Grill the roast at 200 °C on shelf level 1, for approx. 25 minutes, depending on thickness.

Grilling

Grilling guide (Full Grill)

- Use for thick toasts, muffins, cheese on toast, foccacia, bruschetta and bacon.
- Pre-heat grill for at least 15 minutes.
- Select the appropriate shelf level for the thickness of the food.
- Thinner foods can be positioned on shelf 3, while thicker foods should be grilled on shelf 2.
- Grill until food is golden brown and crispy.

Door must be closed for grilling.

Use the Fan Plus  function without setting the temperature for gently defrosting food.

The fan will switch on and circulate air at room temperature around the oven cavity.

 **Danger of salmonella poisoning!**
It is particularly important to observe food hygiene rules when defrosting poultry. Do not use the liquid from the defrosted poultry. Pour it away, and wash the tray, the sink and your hands.

Useful tips

- Where possible, remove the packaging and put the food to be defrosted on the universal tray or into a suitable dish.
- When defrosting poultry, put it on the rack over the universal tray to catch the defrosted liquid so that the meat is not lying in this liquid.
- Meat and poultry need to be fully defrosted before cooking. Fish, on the other hand, can be partially defrosted before cooking. Defrost so that the surface is sufficiently soft to take herbs and seasoning.

Defrosting times

The time needed for defrosting depends on the type and weight of the food, and at what temperature it was deep frozen. The following chart is for guidance only. It is important to check that food is thoroughly defrosted.

Frozen food	Weight [g]	Duration [min.]
Chicken	800	90–120
Meat	500	60–90
	1 000	90–120
Sausages	500	30–50
Fish	1 000	60–90
Strawberries	300	30–40
Butter cake	500	20–30
Bread	500	30–50

Bottling

Containers for bottling

 **Danger of injury!**
Do not use the appliance to heat up or bottle food in sealed jars and tins. Pressure will build up inside them and they can explode causing damage to the appliance, as well as the risk of injury and scalding.

Only use special jars for bottling:

- bottling jars,
- jars with twist-off lids.

Bottling fruit and vegetables

We recommend using Fan Plus .

The instructions are for 6–8 jars with a capacity of 1 litre each.

- Place the universal tray on shelf level 1 and place the jars on the tray.
- Select Fan Plus  and a temperature of 150–170 °C.
- Wait until bubbles evenly rise in the jars.

Reduce the temperature at the right time to avoid the produce boiling over.

Fruit/Cucumbers

- Turn the function selector to Lighting  as soon as bubbles are visible in the jars. Then leave the jars in the oven for a further 25–30 minutes.

Vegetables

- Reduce the temperature to 100 °C as soon as bubbles are visible in the jars.

	 [min.]
Carrots	50–70
Asparagus, peas, beans	80–100

 Bottling duration

- After the bottling duration has finished, turn the function selector to Lighting  and leave the jars in the oven for a further 25–30 minutes.



After bottling

 **Danger of burning!**
Wear oven gloves when removing the jars from the oven.

- Take the jars out of the oven.
- Cover the jars with a towel and leave to set for approx. 24 hours.
- Make sure all jars are closed properly when storing them.

Drying is a traditional method of preserving fruit, certain vegetables and herbs.

It is important that fruit and vegetables are ripe and not bruised before they are dried.

- To prepare food for drying:
 - Peel and core apples, and cut into slices 0.5 cm thick.
 - Core plumbs if necessary.
 - Peel, core and cut pears into wedges.
 - Peel and slice bananas.
 - Clean mushrooms, then either halve or slice them.
 - Remove parsley and dill from the stem.
- Distribute the food evenly over the universal tray.
- Select Fan Plus  or Conventional Heat .
- Select a temperature of 80–100 °C.
- Place the universal tray on shelf level 1.
If you are using Fan Plus , you can dry on shelf levels 1+3 at the same time.

Food	Drying time
Fruit	2–8 hours
Vegetables	3–8 hours
Herbs*	50–60 minutes

* Use Conventional Heat  for drying herbs.

- Reduce the temperature if condensation begins to form in the oven.

 Danger of burning!
Wear oven gloves when removing the dried food from the oven.

- Allow the dried fruit or vegetables to cool down after drying.

Dried fruit must be completely dry, but also soft and elastic. No juice should be left inside fruit.

- Store in tightly sealed jars or cans.

Drying food

Frozen food / Ready-meals

Useful tips

Cakes, pizza, baguettes

- Large frozen items such as cakes, pizzas or baguettes cover an extensive area of the universal tray. The temperature difference if large frozen items are cooked in these trays can cause the tray to distort in such a way that it cannot be removed from the oven when it is hot. Further use will make the distortion worse. Place this type of food on baking paper on the rack to prevent the risk of this happening.
- Use the lowest temperature recommended on the manufacturer's packaging.

Oven chips, croquettes or similar items

- Small items of frozen food such as oven chips can be cooked on the universal tray. Place baking paper on the tray so that they cook gently.
- Use the lowest temperature recommended on the manufacturer's packaging.
- Turn several times during cooking.

Preparation



Eating food which has been cooked correctly is important for preventing food poisoning or other ailments.

Only bake cakes, pizza, chips etc. until they are golden brown. Do not overcook them.

- Select the function and temperature recommended on the manufacturer's packaging.
- Pre-heat the oven.
- Place the food in the oven on the shelf level recommended on the packaging when the temperature indicator light goes out.
- Check the food at the end of the shortest time recommended on the packaging.

The Gentle Bake  programme is ideal for cooking meat.

Examples of use

Food	 [°C]	 [min.]
Ham roast, approx. 1.5 kg	180	130–160
Braised beef, approx. 1.5 kg	180	160–180

 Temperature

 Duration

Unless otherwise stated, the times given are calculated on the basis of an oven which has not been pre-heated.

Use shelf level 1 or 2 depending on the height of the food.

In general, if a range of temperatures is given, it is best to select the lower temperature and to check the food after the shortest time.

Roast with the lid on first, then remove the lid three-quarters of the way through roasting and add approx. 0.5 litre liquid.

Cleaning and care

 Danger of burning! Make sure the oven heating elements are switched off and that the oven cavity is cool.

 Danger of injury! Do not use a steam cleaning appliance to clean this appliance. The steam could reach electrical components and cause a short circuit.

All external surfaces are susceptible to discolouration or change in appearance if unsuitable cleaning agents are used.

Oven cleaners and descaling agents will damage the front of the oven, in particular.

Cleaning agent residues must be removed immediately after use.

All surfaces are also susceptible to scratching. Scratches on glass surfaces could even cause a breakage in certain circumstances.

Unsuitable cleaning agents

To avoid damaging the surfaces of your appliance, do not use:

- cleaning agents containing soda, ammonia, acids or chlorides,
- cleaning agents containing descaling agents on the oven front,
- abrasive cleaning agents, e.g. powder cleaners and cream cleaners,
- solvent-based cleaning agents,
- stainless steel cleaning agents,
- dishwasher cleaner,
- glass cleaning agents,
- cleaning agents for ceramic cooktops,
- hard, abrasive brushes or sponges, e.g. pot scourers, brushes or sponges which have been previously used with abrasive cleaning agents,
- dirt erasers,
- sharp metal tools,
- steel, wool or metal scourers
- spot cleaning,
- oven cleaner*,
- stainless steel spiral pads*.

* These can, however, be used to remove very heavy soiling from PerfectClean treated surfaces in a spot treatment.

Remove any soiling immediately after use. If not, it might become impossible to remove. Continued use without regular cleaning will make the oven much harder to clean.

The accessories are not dishwasher-proof.

Useful tips

- Soiling caused by spilt juices and cake mixtures is best removed whilst the oven is still warm. Exercise caution and make sure the oven is not too hot - danger of burning.
- To make cleaning easier, you can dismantle the oven door, remove the shelf runners and the FlexiClip telescopic runners (if present), and lower the top heat/grill element.

Normal soiling

See "Cleaning the catalytic back panel" for instructions on how to keep the back panel clean.

- It is best to remove normal soiling immediately using a clean sponge and a solution of hot water and washing-up liquid or with a clean, damp microfibre cloth.
- After cleaning, make sure all residual cleaning agents are thoroughly removed with clean water. This is particularly important when cleaning surfaces treated with PerfectClean enamel as cleaning agent residues can impair the non-stick properties.
- After cleaning, wipe the surfaces dry using a soft cloth.

Cleaning the seal

There is a seal around the oven interior which seals the oven interior and the inside of the door.

Grease deposits on the seal can cause it to become brittle and cracked.

- It is advisable to wipe the seal clean after each use.

Cleaning and care

Stubborn soiling (does not apply to the FlexiClip telescopic runners)

Spilt fruit and roasting juices may cause lasting discolouration or matt patches on enamelled surfaces. This discolouration is permanent but will not affect the efficiency of the finish. Do not use force to remove this discolouration! Clean these following the instructions given here.

- Baked on deposits can be removed with a glass scraper or a non-abrasive stainless steel spiral pad.

Remove catalytic panels before using oven spray. The chemicals used in oven sprays will damage catalytic enamel, rendering it ineffective.

- Very stubborn soiling on PerfectClean treated enamel can be cleaned using the Original Miele oven cleaner. It must be applied to cold surfaces in accordance with instructions on the packaging.

Non-Miele oven spray must only be used in a cold oven and for no longer than a maximum of 10 minutes.

- If necessary, the scouring pad on the back of a non-scratching washing-up sponge can be used to remove the soiling.
- After cleaning, remove all oven cleaning agent residues thoroughly with clean water, and dry with a soft cloth.

Stubborn soiling on the FlexiClip telescopic runners

Do not clean FlexiClip telescopic runners in a dishwasher. The special lubricant used in the telescopic runners will wash out during dishwashing.

In the case of stubborn soiling on the surfaces of the telescopic runners, or clogged bearings caused by fruit juices spilling over, proceed as follows:

- Soak the FlexiClip runners for approx. 10 minutes in a solution of hot water and washing-up liquid. If necessary, use the back of a washing-up sponge to remove the soiling. The bearings can be carefully cleaned with a soft brush.

The runners may appear discoloured or a lighter colour in places after they have been cleaned. This will not affect the functioning of the runners in any way.

Cleaning the catalytic enamelled back panel

Soiling from oil and fat is burnt off catalytic enamel when very high temperatures are used in the oven.

The higher the temperature, the more effective the process.

Exposure to scouring agents, abrasive brushes or sponges and oven sprays can cause catalytic enamel to lose its self-cleaning properties.

Catalytic enamelled panels should therefore be taken out of the oven before using oven spray in it.

Removing soiling caused by spices, sugar and similar deposits

- Remove the back panel (see "Cleaning and care - Removing the back panel").
- Clean the back panel by hand with a solution of hot water and washing-up liquid applied with a soft brush.
- Rinse it thoroughly and then leave it to dry before fitting it back in the oven.

Cleaning and care

Removing oil and grease soiling from the catalytic enamelled panel

- Remove any accessories from the oven, including the shelf runners.
- Wipe large deposits of soiling from the oven interior and the inside of the door before starting the cleaning process to avoid them baking on.
- Select the Fan Plus  function and a temperature of 250 °C.
- Then heat the empty oven for at least an hour.

The length of time required will depend on the level of soiling.

If the catalytic coating is very heavily soiled with oil and grease, a film can form on the surfaces of the oven interior during the cleaning process.

 Danger of burning! Allow the oven to cool down before cleaning by hand.

- Clean the inside of the door and the oven interior with a clean sponge and a solution of hot water and washing-up liquid or a clean, damp microfibre cloth.

Any remaining soiling on the panel will gradually disappear with each subsequent use of the oven at high temperatures.

Removing the door

The oven door is connected to the hinges by retainers.

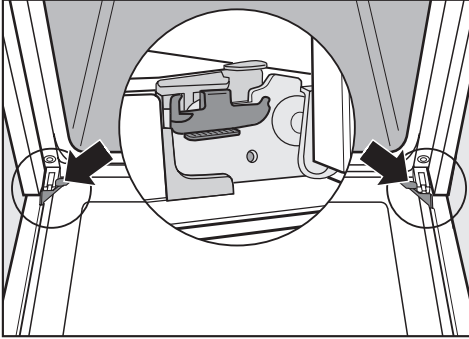

Before removing the door from the retainers, the locking clamps on both hinges have to be released.

- Open the door fully.

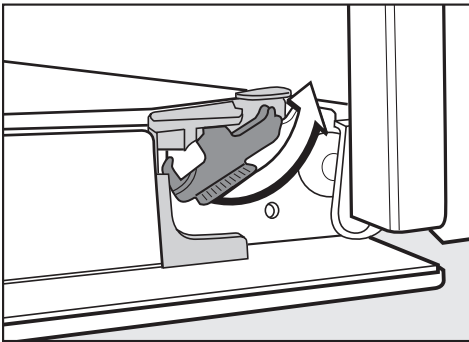

- Release the locking clamps by turning them as far as they will go.

Do not attempt to take the door off the retainers when it is in the horizontal position as the retainers will spring back against the oven.

Do not use the handle to pull the door off the retainers as the handle could break.

- Raise the door up till it rests open.



- Hold the door securely at both sides, and lift it upwards off the retainers. Make sure you take it off straight.

Cleaning and care

Dismantling the door

The oven door is an open system with two glass panes which have a heat-reflective coating on some of their surface.

During operation, cool air is passed through the oven door to keep the outer pane cool.

If soiling has worked its way in between the glass panes, the door can be dismantled in order to clean in between the panes.

Take particular care as scratches can damage the glass. When cleaning the glass panes, do not use abrasive cleaning agents, hard sponges or brushes and do not use sharp metal tools or scrapers. Please also read the general notes on cleaning the oven front before cleaning the glass panes.

Oven spray will damage the aluminium trims inside the door. These should only be cleaned using hot water and washing-up liquid applied with a clean sponge or a clean, damp microfibre cloth.

Be especially vigilant after dismantling the door that the glass panes do not break.

 Danger of injury.
Always remove the door before dismantling it.

- Place the door on a protective surface (e.g. on a table cloth) to prevent it getting scratched. The door handle should line up with the edge of the table. Make sure the glass lies flat and does not get broken during cleaning.

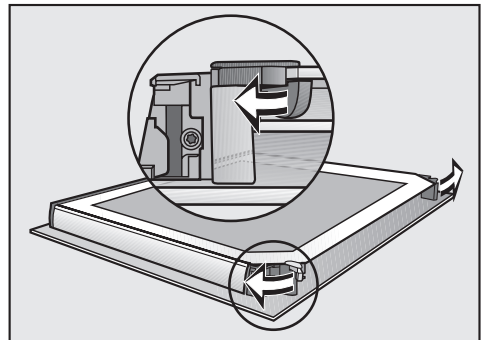

- Flip the two glass pane retainers outwards to open them.

To remove the inner panes:

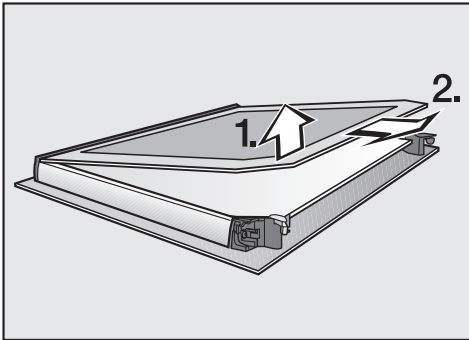

- **Gently** lift the inner pane up and out of the plastic strip.

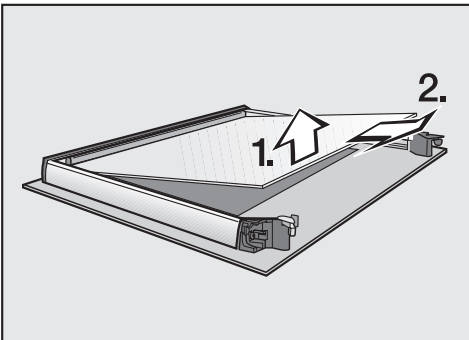

- Lift the middle pane up **gently** and pull it out.
- Remove the seal from the pane.

- Clean the door panes and other individual parts with a clean sponge and a solution of hot water and washing-up liquid or a clean, damp microfibre cloth.
- Dry all parts with a soft cloth.

Then reassemble the door carefully:

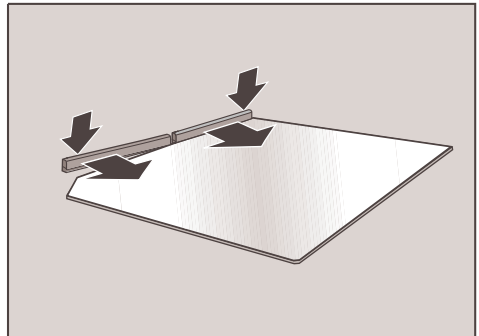

- Secure the seal to the middle pane.

Cleaning and care

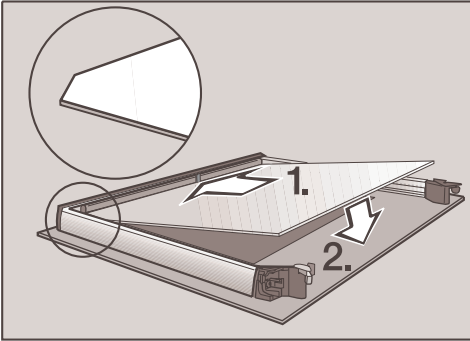

- Refit the middle pane and the seal.

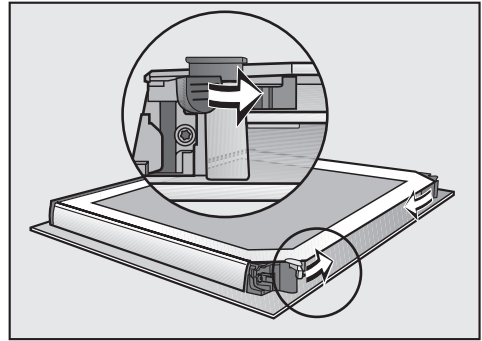

- Flip the two glass pane retainers inwards to close them.

The door is now reassembled and is ready to fit back on the oven.

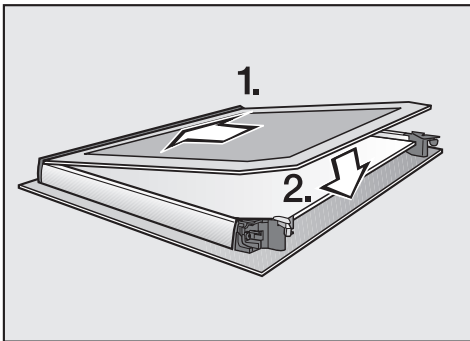

- Push the inner pane with the matt printed side facing downwards into the plastic strip and place it between the retainers.

Fitting the door

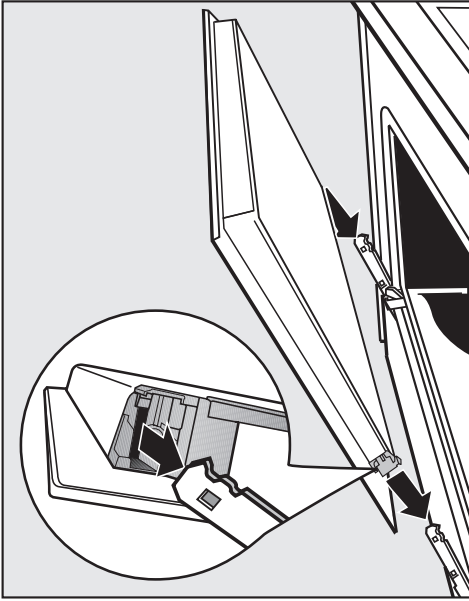

- Hold the door securely on both sides and carefully fit it back into the hinge retainers. Make sure that the door goes back on straight.

- Open the door fully.

It is essential that the locking clamps lock securely when the door is refitted after cleaning. Otherwise the door could work loose from the retainers and be damaged.

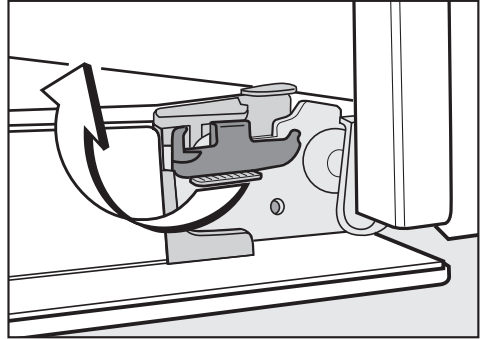

- Flip both locking clamps back up as far as they will go into a horizontal position.

Cleaning and care

Removing the shelf runners with FlexiClip telescopic runners

 Danger of injury!
Do not use the oven without the shelf runners.

You can remove the shelf runners together with the FlexiClip telescopic runners (if present).

If you wish to remove the FlexiClip telescopic runners separately beforehand, please follow the instructions in "Features – Fitting and removing the FlexiClip telescopic runners".

 Danger of burning!
Make sure the oven heating elements are switched off and the oven interior is cool.

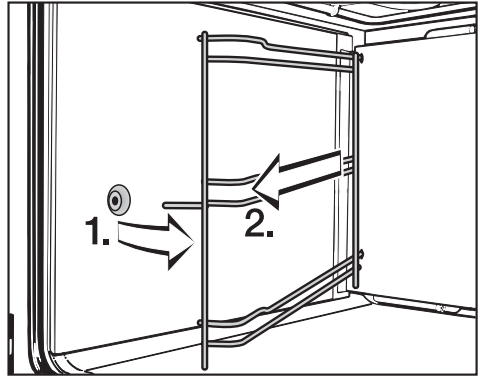

- Pull the runners out of the holder (1) at the front of the oven and then pull them out of the oven (2).

Refit in the reverse order.

- Ensure that all parts are correctly fitted.

Removing the back panel

 **Danger of injury!**
Do not use the oven without the back panel fitted.

The back panel can be removed for cleaning purposes.

 **Danger of burning!**
Make sure the oven heating elements are switched off and the oven interior is cool.

- Disconnect the appliance from the mains. Switch off at the wall and withdraw the plug from the socket, or switch off at the mains circuit breaker.
- Remove the shelf runners.
- Undo the four screws in the corners of the back panel and take it out.
- Clean the back panel (see "Cleaning and Care - Cleaning the catalytic back panel").

Refit in the reverse order.

Carefully refit the back panel. The air inlets must appear as they do in "Oven overview".

- Reconnect the oven to the electricity supply.

Lowering the top heat/grill element

 **Danger of burning!**
Make sure the oven heating elements are switched off and the oven interior is cool.

- Remove the shelf runners.

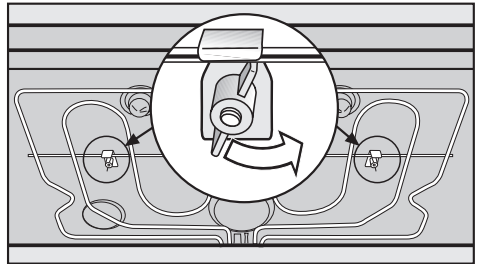

- Undo the wing nuts.

Do not use force to lower the top heat/grill element as this can cause it to break.

- Carefully lower the top heat/grill element.

You can now clean the oven ceiling.

- Raise the top heat/grill element and tighten the wing nuts securely.
- Refit the shelf runners.

Problem solving guide

With the aid of the following guide, minor problems can be easily corrected without contacting Miele. If, after reading this guide, you can't remedy the problem yourself, please call Miele (see back cover for details).

Please note, however, that a call-out charge will be applied to unnecessary service visits where the problem could have been rectified as described in these operating instructions.

Danger of injury!

Installation, maintenance and repairs may only be carried out by a suitably qualified and competent person. Repairs and other work by unqualified persons could be dangerous.

Miele cannot be held liable for unauthorised work.

Do not attempt to open the casing of the oven yourself.

Problem	Possible cause and remedy
The display is dark.	<p>There is no power to the oven.</p> <ul style="list-style-type: none">■ Check whether the mains fuse has tripped. If it has, contact a qualified electrician or Miele.
The oven does not heat up.	<p>You have only selected an oven function or a temperature.</p> <ul style="list-style-type: none">■ Select both a function and a temperature.
	<p>The system lock  has been switched on.</p> <ul style="list-style-type: none">■ Switch off the system lock (see "Clock/Timer - Changing settings").
	<p>There is no power to the oven.</p> <ul style="list-style-type: none">■ Check whether the mains fuse has tripped. If it has, contact a qualified electrician or Miele.

Problem solving guide

Problem	Possible cause and remedy
<i>12:00</i> starts flashing in the display.	There has been a power cut. ■ Reset the time of day (see "Using for the first time"). Cooking durations will also need to be reset for any programme in use.
A noise can be heard after a cooking process.	The cooling fans will continue to run for a while after the oven has been switched off to prevent any humidity building up in the oven, on the control panel or in the oven housing unit. The fans will switch off automatically after a certain time.
Rust-like spots appear on catalytic surfaces.	The catalytic cleaning process does not remove spices, sugar and similar deposits. Take catalytic panels out of the oven and remove this type of soiling with a mild solution of hot water and washing-up liquid applied with a soft brush (see "Cleaning and care - Cleaning the catalytic back panel").

Problem solving guide

Problem	Possible cause and remedy
Cakes and biscuits are not cooked properly after following the times given in the chart.	<p>A different temperature from the one given in the recipe was used.</p> <ul style="list-style-type: none"> ■ Select the temperature required for the recipe. <p>The ingredient quantities are different from those given in the recipe.</p> <ul style="list-style-type: none"> ■ Check whether there has been a change to the recipe. The addition of more liquid or more eggs makes a moister mix which would take longer to cook.
Browning is uneven.	<p>The wrong temperature or shelf level was selected.</p> <ul style="list-style-type: none"> ■ There will always be a slight unevenness. If the unevenness is pronounced, check whether the correct temperature and shelf level have been selected. <p>The material or colour of the baking tin is not suitable for the oven function.</p> <ul style="list-style-type: none"> ■ With Conventional Heat  light-coloured, shiny tins are less suitable. Use matt, dark-coloured tins.
FlexiClip telescopic runners do not push in or pull out smoothly.	<p>The bearings in the FlexiClip telescopic runners are not sufficiently lubricated.</p> <ul style="list-style-type: none"> ■ Lubricate the bearings with the special Miele lubricant. Only use this special lubricant as it is designed to withstand high temperatures in the oven. Other lubricants can harden and stick to the telescopic runners when they are heated. The Miele lubricant is available to order from Miele.

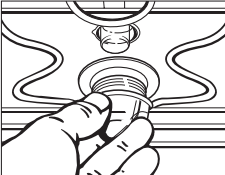
Problem	Possible cause and remedy
The oven lighting does not switch on.	You have selected Gentle Bake  . The oven lighting does not come on with this function.
	<p>The halogen lamp needs replacing.</p> <div data-bbox="378 347 1043 475" style="border: 1px solid black; padding: 5px;"><p>Danger of burning! Make sure the oven heating elements are switched off and the oven interior is cool.</p></div> <ul style="list-style-type: none">■ Disconnect the appliance from the mains. Switch off at the wall and withdraw the plug from the socket, or switch off at the mains circuit breaker.  <ul style="list-style-type: none">■ Turn the lamp cover a quarter turn anti-clockwise to release it and then pull it together with its seal downwards to take it out.■ Replace it with a new halogen lamp (Osram 66725 AM/A, 230 V, 25 W, G9).■ Refit the lamp cover together with its seal and turn clockwise to secure.■ Reconnect the oven to the electricity supply.

After sales service and warranty

After sales service

In the event of any faults which you cannot easily remedy, please contact Miele.

See back cover for contact details.

Please quote the model and serial number of your appliance when contacting Miele.

This information is given on the data plate, visible on the front frame of the oven, with the door fully open.

Warranty

This appliance has a manufacturer's warranty period of 2 years.

For further information, please refer to your warranty booklet.



Danger of injury!

All electrical work should be undertaken by a suitably qualified and competent person.

Installation, repairs and other work by unqualified persons could be dangerous. Miele cannot be held liable for unauthorised work.

Ensure power is not supplied to the appliance until after installation or repair work has been carried out.

Connection of this appliance should comply with national and local safety regulations.

Connection to a switched socket is recommended as this provides easier access and isolation in the case of a service call.

If the switch is not accessible after installation or the appliance is **hard-wired** (depending on country), an additional means of disconnection must be provided for all poles.

When switched off there must be an all-pole contact gap of 3 mm in the isolator switch (including switch, fuses and relays according to EN 60335).

Connection data

The required connection data can be found on the data plate located on the oven frame visible when the door is open.

Please ensure this information matches the household mains supply.

When contacting Miele, please quote the following:

- model number,
- serial number,
- connection data (voltage/frequency/maximum rated load).

When replacing the connection cable supplied with another cable, or changing the connection, only cable type H 05 VV-F with a suitable cross-sectional area (CSA) may be used (available from Miele).

Electrical connection

Oven

The oven is supplied for connection to a single-phase 230 V, 50 Hz supply with a 3-core cable.

The wires in the mains lead are coloured in accordance with the following code:

Green/yellow = earth

Blue = neutral

Brown = live

WARNING

THIS APPLIANCE MUST BE EARTHED

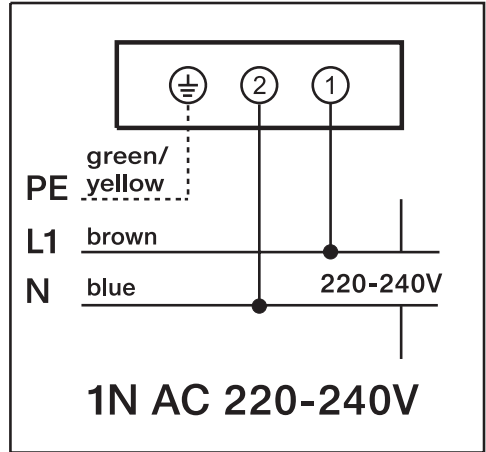

Appliance dimensions and unit cut-out

All measurements are given in mm.

Installation in a base unit

HAL (90 cm) trim, available as an optional accessory, is only required when building the oven into a base unit.

- Fix the HAL (90 cm) trim into the unit cut-out under the worktop (see lower section of diagram).

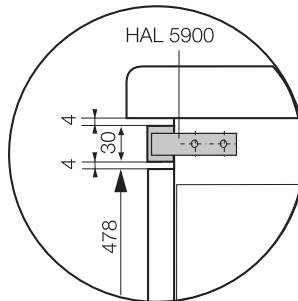
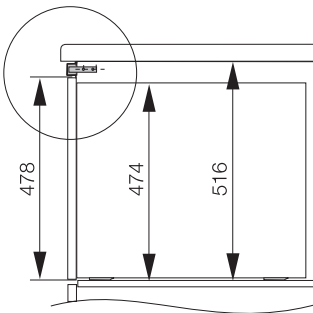
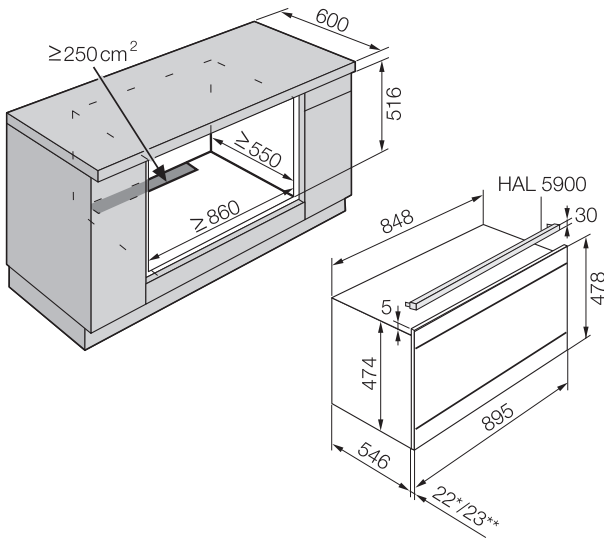

* Ovens with glass front

** Ovens with metal front

Building-in diagrams

Installation in a tall unit

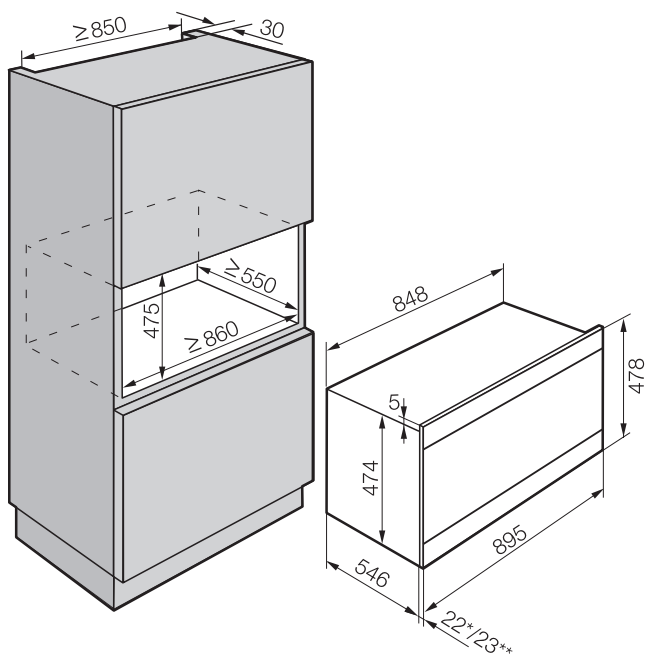

* Ovens with glass front

** Ovens with metal front

Front dimensions

Dimensions are given in mm.

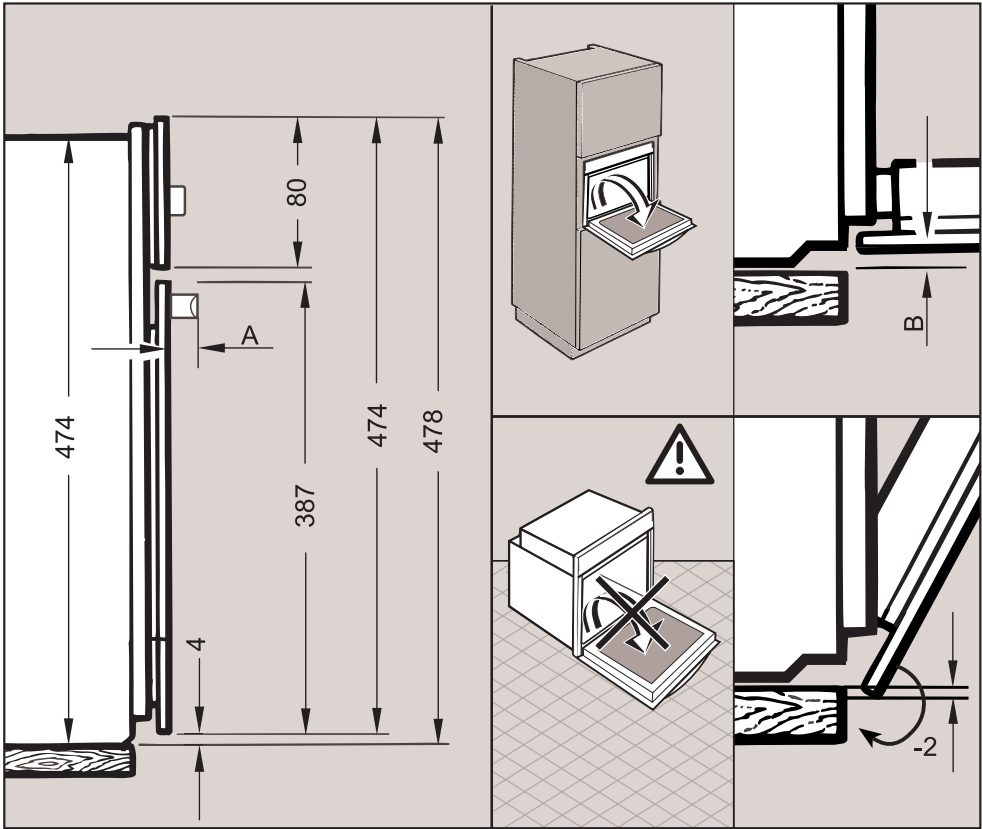

A 42 mm

B Ovens with glass front: 2.2 mm
Ovens with metal front: 1.2 mm

Installing the oven

 The oven must be built into its housing unit before it can be used.

In order to function correctly, the oven requires an adequate supply of cool air.

Ensure that the supply of cool air is not impaired:

- do not fit a back panel in the housing unit.
- the unit shelf on which the oven sits must not touch the wall behind it.
- do not fit insulation to the side walls of the housing unit.

Please also ensure that the cool air supply is not unduly heated by other heat sources such as a wood burning stove.

Before installation

- Before connecting the oven to the mains, you must disconnect the power supply to the oven isolator switch.

Installing the oven

- Connect the mains cable from the oven to the isolator.

Lifting the oven by the door handle can damage the door.

It is advisable to remove the door before installing the appliance (see "Cleaning and Care - Removing the door") and remove accessories from the oven cavity. This will make it easier to install in its niche and you will not be tempted to use the handle to carry it.

Remove the carry handles at the sides.

- Push the oven into the housing unit and align it.
- Open the door (if you have not removed it previously).

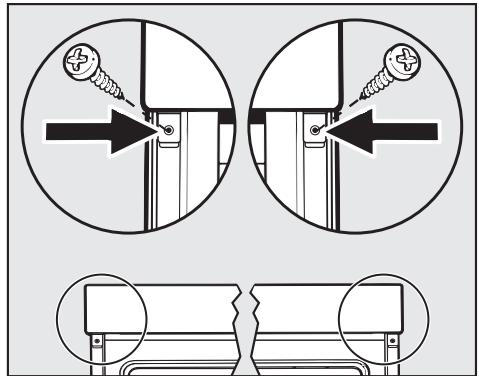

- Use the screws supplied to secure the oven to the side walls of the housing unit through the holes in the oven trim.
- Refit the door, if necessary (see "Cleaning and care - Refitting the door").

Miele Australia Pty. Ltd.

ACN 005 635 398
ABN 96 005 635 398

Miele Center and Head Office Melbourne:

1 Gilbert Park Drive
Knoxfield, VIC 3180

Miele Center and Office Melbourne:

206-210 Coventry Street
South Melbourne, VIC 3205

Miele Center and Office Sydney:

3 Skyline Place
Frenchs Forest, NSW 2086

Miele Center and Office Brisbane:

39 Harvey Street North
Eagle Farm, QLD 4009

Miele Center and Office Adelaide:

83-85 Sir Donald Bradman Drive
Hilton, SA 5033

Miele Center and Office Perth:

205-207 Stirling Highway
Claremont, WA 6010



www.miele.com.au



Miele New Zealand Limited

IRD 98 463 631

Head Office:

Level 2, 10 College Hill
Freemans Bay, Auckland 1011

Miele Center Auckland:

8 College Hill
Freemans Bay, Auckland 1011

Telephone:

0800 4 MIELE (0800 464 353)

www.miele.co.nz

Miele Global Headquarters

Germany

Miele & Cie. KG

Carl-Miele-Straße 29
33332 Gütersloh
Federal Republic of Germany

H6290B



en - AU, NZ

M.-Nr. 10 011 630 / 01